

Overview

150–400 V

- High Power AC and DC Power Source**
 Programmable AC and DC power for frequency conversion and product test applications
- Expandable Power Levels**
 Available output power of 15, 30, and 45 kVA per unit and multi-unit configurations for power requirements up to 135 kVA and above
- Single and Three Phase Mode**
 Phase mode programming on MX30-3Pi and MX45-3Pi allows switching between single and three phase output modes
- Arbitrary & Harmonic Waveform Generation**
 User defined voltage waveform and distortion programming
- Regenerative, bidirectional “Green” Power Solution**
 Automatic crossover between Source and Sink power mode offers regenerative capabilities in AC, AC+DC and DC modes. Regenerate up to 100% of the rated output power back to the utility grid during sink mode operation. (-SNK option)
- Remote Control**
 Standard RS232C & USB along with optional IEEE-488 & LAN Interfaces are available for automated test applications



USB and LAN remote control interfaces and instrument drivers for popular ATE programming environments are available. This allows the MX Series to be easily integrated into an automated test system.

For advanced test applications, the programmable controller version offers full arbitrary waveform generation, time and frequency domain measurements, and voltage and current waveform capture.

Configurations

The MX15 delivers up to 15 kVA of single phase output. The MX30 delivers up to 30 kVA, and the MX45 up to 45 kVA. Both operate using single or three phase output in AC mode. In DC mode, 50% of the AC power level is available. On MX-P models, AC+DC mode is also supported.

For higher power requirements, the MX90 and MX135 models are available. Multi cabinet MX45 systems always operate in three phase output mode. Available reconfigurable MX90 and MX135 models (-MB designation) provide multiple controllers which allow separation of the high power system into two or three individual MX45 units for use in separate applications. This ability to reconfigure the system provides an even greater level of flexibility not commonly found in power systems.

Product Evaluation and Test

Increasingly, manufacturers of high power equipment and appliances are required to fully evaluate and test their products over a wide range of input line conditions. The built-in output transient generation and read-back measurement capability of the MX Series offers the convenience of a powerful, and easy to use, integrated test system.

Introduction

The MX Series consists of multiple high power AC and DC power systems that provide controlled AC and DC output for ATE and product test applications.

This high power AC and DC test system covers a wide spectrum of AC and DC power applications at an affordable cost. Using state-of-the-art PWM switching techniques, the MX series combines compactness, robustness and functionality in a compact floor-standing chassis, no larger than a typical office copying machine. This higher power density has been accomplished without the need to resort to elaborate cooling schemes or additional installation wiring. Simply roll the MX15, MX30, or MX45 unit to its designated location (using included casters), plug it in, and the MX series is ready to work for you.

Simple Operation

The MX Series can be operated completely from its menu driven front panel controller. A backlit LCD display shows menus, setup data, and read-back measurements. IEEE-488, RS232C,

0–375 A / Phase

	208	230	400
	480		

ETHERNET   RS232

Distributed by:
www.SignalTestInc.com
 1529 Santiago Ridge Way
 San Diego, CA 92154 USA.
Sales@SignalTestInc.com

SIGNAL TEST
 New & Used Test Equipment

Regenerative, bidirectional “Green” Power Solution

The MX Series features the ability to both source and sink current, i.e. bi-directional current flow. The MX amplifier is designed to reverse the phase relationship between the AC input voltage and current in order to feed power back onto the utility grid. This mode of operation is particularly useful when testing grid-tied products that feed energy back onto the grid. Static Power Converters such as grid-tied and off-grid photovoltaic inverters are tested for frequency variations, voltage transients, DC injection and harmonic susceptibility.

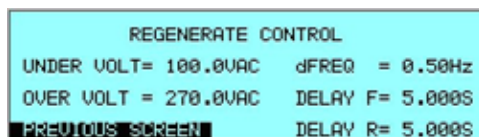

Programming sink (-SNK) mode operation

Avionics

With an output frequency range to 819 Hz (or 1000 Hz with -HF option), the MX Series is well suited for aerospace applications. Precise frequency control and accurate load regulation are key requirements in these applications. The available IEEE-488 remote control interface and SCPI command language provide for easy integration into existing ATE systems. The MX Series eliminates the need for several additional pieces of test equipment, saving cost and space. Instrument drivers for popular programming environments such as National Instruments LabView™ are available to speed up system integration.

Regulatory Testing

As governments are moving to enforce product quality standards, regulatory compliance testing is becoming a requirement for a growing number of manufacturers. The MX Series is designed to meet AC source requirements for use in compliance testing such as IEC 61000, 3-2, 3-3, 3-11, 3-12, to name a few.

Choice of voltage ranges

The MX30 and MX45 can be ordered with either a 150 V RMS Line to Neutral output voltage range or a 300 V RMS Line to Neutral range. This provides 3 phase output capability of 260 Vac or 520 Vac line to line respectively. If dual output

ranges are required, the programmable range change option (-R) provides the ability to switch between both output ranges. Pi version models offer standard dual voltage ranges.

For applications requiring more than 300 V L-N (or 520 V L-L), the optional -HV output transformer provides an additional 400 V L-N and 693 V L-L output range for use in AC mode only.

Multi-Box Configurations

For high power applications, two or three MX45 chassis can be combined to provide 90 to 135 kVA of three phase power. MX90 and MX135 systems are always configured for three phase operation. Contact sales for custom configurations.

High Crest Factor

With a crest factor of up to 3.6, the MX Series AC source can drive difficult nonlinear loads with ease. Since many modern products use switching power supplies, they have a tendency to pull high repetitive peak currents. The MX30-3Pi can deliver up to 240 Amps of repetitive peak current (150 V AC range) per phase to handle three phase loads.

Remote Control

Standard RS232C & USB IEEE-488 along with optional LAN remote control interfaces allow programming of all instrument functions from an external computer. The popular SCPI command protocol is used for programming.

Application Software

Windows® application software is included. This software provides easy access to the power source's capabilities without the need to develop any custom code. The following functions are available through this GUI program:

- Steady state output control (all parameters)
- Create, run, save, reload and print transient programs
- Generate and save harmonic waveforms.
- Generate and save arbitrary waveforms.
- Measure and log standard measurements
- Capture and display output voltage and current waveforms.
- Measure, display, print and log harmonic voltage and current measurements.
- Display IEEE-488, RS232C, USB and LAN bus traffic to and from the AC Source to help you develop your own test programs.

1. Requires PC running WindowsXP™ or Windows 2000™.

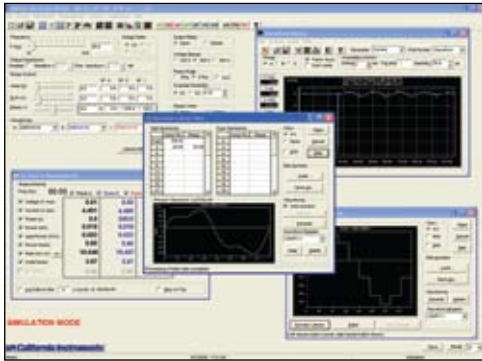

Harmonic Waveform Generation

Using the latest DSP technology, the MX Series programmable controller is capable of generating harmonic waveforms to test for harmonics susceptibility. The Windows Graphical User Interface program can be used to define harmonic waveforms by specifying amplitude and phase for up to 50 harmonics. The waveform data points are generated and downloaded by the GUI to the AC source through the IEEE-488 or RS232C bus. Up to 200 waveforms can be stored in nonvolatile memory and given a user defined name for easy recall.

All MX-Pi Series configurations offer three phase waveform generation, allowing independent phase anomalies to be programmed. It also allows simulation of unbalanced harmonic line conditions.

Arbitrary Waveform Generation

Using the provided GUI program or custom software, the user also has the ability to define arbitrary AC waveforms. The arbitrary waveform method of data entry provides an alternative method of specifying AC anomalies by providing specific waveform data points. The GUI program provides a catalog of custom waveforms and also allows real-world waveforms captured on a digital oscilloscope to be downloaded to one of the many AC source's waveform memories. Arbitrary waveform capability is a flexible way of simulating the effect of real-world AC power line conditions on a unit under test in both engineering and production environments.



Harmonic waveform, Fund., 3rd, 5th, 7th, 9th, 11th and 13th.

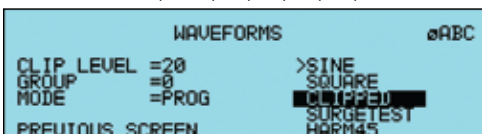

Two hundred user defined waveforms.

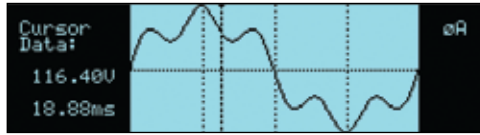

Harmonically distorted waveform.

MX Series - AC and DC Transient Generation

The MX Series controller has a powerful AC and DC transient generation system that allows complex sequences of voltage, frequency and waveshapes to be generated. This further enhances the MX's capability to simulate AC line conditions or DC disturbances. When combined with the multiphase arbitrary waveform capabilities, the AC and DC output possibilities are truly exceptional. Transient generation is controlled independently yet time synchronized on all three phases. Accurate phase angle control and synchronized transient list execution provide unparalleled accuracy in positioning AC output events.

Transient programming is easily accomplished from the front panel where clearly laid out menu's guide the user through the transient definition process.

The front panel provides a convenient listing of the programmed transient sequence and allows for transient execution Start, Stop, Abort and Resume operations. User defined transient sequences can be saved to non-volatile memory for instant recall and execution at a later time. The included Graphical User Interface program supports transient definitions using a spreadsheet-like data entry grid. A library of frequently used transient programs can be created on disk using this GUI program.

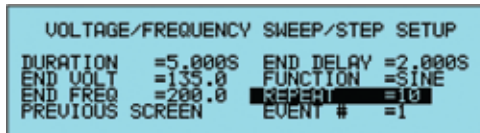

Transient List Data Entry from the front panel.

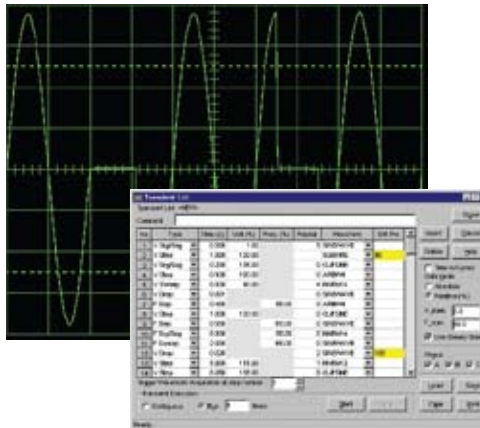

Transient List Data Entry in GUI program.

MX Series II

MX Series - Measurement and Analysis

The MX Series is much more than a programmable AC, DC or AC+DC power source. It also incorporates an advanced digital signal processor based data acquisition system that continuously monitors all AC source and load parameters. This data acquisition system forms the basis for all measurement and analysis functions. These functions are accessible from the front panel and the remote control interface for the MX Series (MX15 excluded; uses 2-line display shown below).

Conventional Measurements [All controllers]

Common AC and DC measurement parameters are automatically provided by the data acquisition system. These values are displayed in numeric form on the front panel LCD display. The following measurements are available: Frequency, Vrms, Irms, Ipk, Crest Factor, Real Power (Watts), Apparent Power (VA) and Power Factor.

Harmonic Analysis

The MX Series provides detailed amplitude and phase information on up to 50 harmonics of the fundamental voltage and current (up to 16 kHz in three phase mode) for either one or three phases. Harmonic content can be displayed in both tabular and graphical formats on the front panel LCD for immediate feedback to the operator (excluding MX15). Alternatively, the included GUI program can be used to display, print and save harmonic measurement data. Total harmonic distortion of both voltage and current is calculated from the harmonic data.

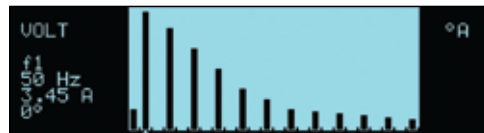

Absolute amplitude bar graph display of current harmonics with cursor positioned at the fundamental (MX30/45 Display).

HR#	AMPL.	PHASE	HR#	AMPL.	PHASE
0	0.00	0.0	1	151.42	0.0
2	0.33	46.9	3	116.17	351.4
4	0.57	90.1	5	85.24	29.6
6	0.59	131.0	7	54.72	67.0
8	0.45	171.4	9	24.55	100.6

Voltage harmonic measurement table display in absolute values (MX30/45 Display)

Waveform Acquisition

The measurement system is based on real-time digitization of the voltage and current waveforms using a 4K deep sample buffer. This time domain information provides detailed information on both voltage and current waveshapes. Waveform acquisitions can be triggered at a specific phase angle or from a transient program to allow precise positioning of the captured waveform with respect to the AC source output.

The front panel LCD displays captured waveforms with cursor readouts (excluding MX15). The included GUI program also allows acquired waveform data to be displayed, printed, and saved to disk.

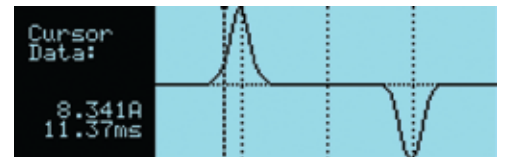

Acquired Current waveform (MX30/45 Display).

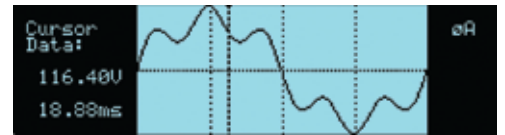

Acquired Voltage waveform (MX30/45 Display).

MEASUREMENTS 1			
VOLTAGE =	113.5VAC	FREQ =	60.0Hz
CURRENT =	36.9A	POWER =	4.11KW
PREVIOUS SCREEN			

Measurement data for single phase (MX30/45 Display).

MEASUREMENTS1				oA	oB	oABC
FREQ	=	60.0	Hz			
VOLT AC	=	120.51	U	120.31	U	
CURR	=	34.42	A	0.454	A	0.129
POWER	=	0.782	KW	0.163	KW	0.754
PREVIOUS SCREEN						

Measurement data for all three phases (MX30/45 Display).

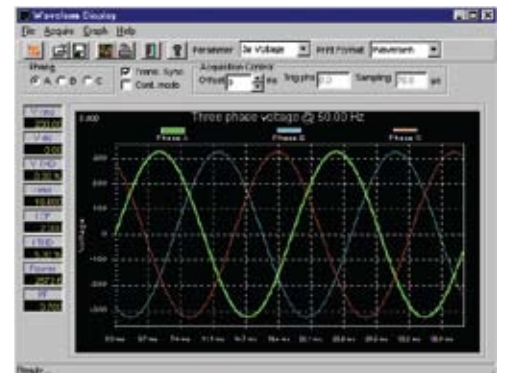

Acquired three phase voltage waveforms display on PC.

Operating Modes																			
Pi Version	AC, DC and AC+DC																		
AC Mode Output																			
Frequency	Range: 16.00-819.0 Hz, -LF Option: 16.00-500.0 Hz, -HF Option: 16.00-1000 Hz (supplemental specifications apply above 819 Hz). Resolution: 0.01 Hz: 16.00 - 81.91 Hz, 0.1 Hz: 82.0 Hz - 819.1 Hz, 1 Hz: 820-1000 Hz																		
Phase Outputs	MX15-1/15-1Pi: 1, MX30/45-3Pi: 1 or 3 switchable, Neutral: Floating, Coupling: DC (except for -HV option)																		
Total Power	MX15-1/1Pi: 15 kVA, MX30-1/3: 30 kVA, MX45-1/3: 45 kVA, MX90: 90 kVA, MX135: 135 kVA																		
Load Power Factor	0 to unity at full output current																		
AC Mode Voltage																			
Voltage Ranges	<table border="1"> <thead> <tr> <th>Range</th> <th>V Low</th> <th>V High</th> <th>Load Regulation</th> <th>< 0.25 % FS DC to 100 Hz, < 0.5 % FS 100 Hz to 819 Hz</th> </tr> </thead> <tbody> <tr> <td>AC</td> <td>0-150 V</td> <td>0-300 V</td> <td>Line Regulation</td> <td>< 0.1% FS for 10 % line change</td> </tr> <tr> <td>AC+DC</td> <td>0-150 V</td> <td>0-300 V</td> <td></td> <td></td> </tr> </tbody> </table>	Range	V Low	V High	Load Regulation	< 0.25 % FS DC to 100 Hz, < 0.5 % FS 100 Hz to 819 Hz	AC	0-150 V	0-300 V	Line Regulation	< 0.1% FS for 10 % line change	AC+DC	0-150 V	0-300 V					
	Range	V Low	V High	Load Regulation	< 0.25 % FS DC to 100 Hz, < 0.5 % FS 100 Hz to 819 Hz														
	AC	0-150 V	0-300 V	Line Regulation	< 0.1% FS for 10 % line change														
AC+DC	0-150 V	0-300 V																	
External Sense	Voltage drop compensation (5% Full Scale)																		
Harmonic Distortion (Linear)	Less than 0.5% from 16 - 66 Hz, Less than 1% from 66 - 500 Hz, Less than 1.25% above 500 Hz																		
DC Offset	< 20 mV																		
Load Regulation	0.25% FS @ DC - 100 Hz, 0.5% FS > 100 Hz																		
External Amplitude Modulation	Depth: 0 - 10 %, Frequency: DC - 2 KHz																		
Voltage slew rate	200 μ s for 10% to 90% of full scale change into resistive load, 0.5V / μ Sec																		
AC Mode Current																			
Steady State AC Current @ FS V	<table border="1"> <thead> <tr> <th>Model</th> <th>MX15-1Pi</th> <th>MX30-3Pi / 1Pi</th> <th>MX45-3Pi / 1Pi</th> <th>MX90-3Pi</th> <th>MX135-3Pi</th> </tr> </thead> <tbody> <tr> <td>V Low</td> <td>100</td> <td>66.6/ø / 200</td> <td>100/ø / 300</td> <td>200/ø</td> <td>300/ø</td> </tr> <tr> <td>V High</td> <td>50</td> <td>33.3/ø / 100</td> <td>50/ø / 150</td> <td>100/ø</td> <td>150/ø</td> </tr> </tbody> </table>	Model	MX15-1Pi	MX30-3Pi / 1Pi	MX45-3Pi / 1Pi	MX90-3Pi	MX135-3Pi	V Low	100	66.6/ø / 200	100/ø / 300	200/ø	300/ø	V High	50	33.3/ø / 100	50/ø / 150	100/ø	150/ø
	Model	MX15-1Pi	MX30-3Pi / 1Pi	MX45-3Pi / 1Pi	MX90-3Pi	MX135-3Pi													
	V Low	100	66.6/ø / 200	100/ø / 300	200/ø	300/ø													
V High	50	33.3/ø / 100	50/ø / 150	100/ø	150/ø														
Note: Constant power mode provides increased current at reduced voltage. See chart below																			
Peak Repetitive AC Current	Up to 3.6 x rms current at full scale voltage																		
Programming Accuracy	Voltage (rms): ± 0.3 Vrms, Frequency: ± 0.01 % of programmed value, Current Limit: - 0 % to + 5 % of programmed value + 1A, Phase: < 0.5° + 0.2°/ 100 Hz with balanced load																		
Programming Resolution	Voltage (rms): 100 mV, Frequency: 0.01 Hz from 16 - 81.91 Hz, 0.1 Hz from 82.0 - 819 Hz, Current Limit: 0.1 A, 3 phase mode, 1.0 A, 1 phase mode, Phase: 0.1°																		

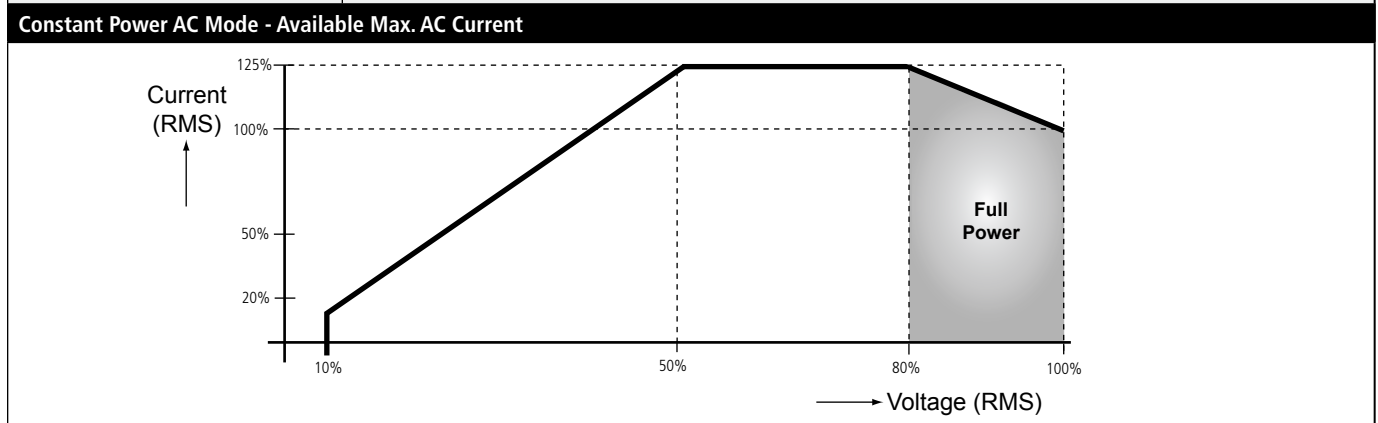

Note: Specifications are subject to change without notice. Specifications are warranted over an ambient temperature range of 25 \pm 5° C. Unless otherwise noted, specifications are per phase for a sine wave with a resistive load and apply after a 30 minute warm-up period. For three phase configurations, all specifications are for L-N. Phase angle specifications are valid under balanced load conditions only.

© 2009 AMETEK Programmable Power All rights reserved. AMETEK Programmable Power is the trademark of AMETEK Inc., registered in the U.S. and other countries. Elgar, Sorensen, California Instruments, and Power Ten are trademarks of AMETEK Inc., registered in the U.S.

MX Series II : Specifications

Measurement													
Measurements - Standard (AC Measurements)	Parameter	Frequency	RMS Voltage	RMS Current	Peak Current	Crest Factor	Real Power	Apparent Power	Power Factor	Phase	DC Voltage	DC Current	Power
	Range	16-100 Hz 100-820 Hz	0-400 V	0-160 A	0-400 A	0.00-6.00	0-15 kW	0-15 kVA	0.00-1.00	0.0-360.0	0-400 V	0-160 A	Power
	Accuracy* (±)	0.01% + 0.01 Hz	0.05 V + 0.02%	0.15 A + .02%	0.15 A + 0.02%	0.05	30 W + 0.1%	30 VA + 0.1%	0.01	2.0°	0.5 V	0.5 A	0.15 kW
	Resolution*	0.01 Hz / 0.1 Hz	0.1 V + 0.02%	0.3 A + 0.02%	0.3 A + 0.02%	0.05	60 W + 0.1%	60 VA + 0.1%	0.02	3.0°			10 W
* Measurement system bandwidth = DC to 6.7 kHz. Accuracy specifications are valid above 100 counts. Current and Power Accuracy and Range specifications are times three for MX90, MX135 or MX30/45-3Pi in single phase mode. PF accuracy applies for PF > 0.5 and VA > 50 % of range													
Measurements - Harmonics (Pi controller only)	Parameter	Frequency Fundamental Harmonics		Phase	Voltage			Current					
	Range	16.00-1000.0 Hz / 32.00 Hz - 16 kHz		0.0 - 360.0°	Fundamental Harmonics 2-50			Fundamental Harmonics 2-50					
	Accuracy* (±)	0.03% + 0.03 Hz / 0.01 Hz		2° typ.	750 mV 0.3% + 750 mV+0.3% / 1 kHz			0.5 A / 0.3% + 150 mA +0.3% / 1 kHz					
	Resolution	0.01 Hz		0.5°	10 mV / 10 mV			100 mA / 100 mA					
* Accuracy specifications are valid above 100 counts. Accuracy specifications are for three phase mode. Harmonics frequency range for MX30/45-3Pi in single phase mode is 32 Hz - 48 kHz													
DC Mode Output													
Power	Maximum DC power at full scale of DC voltage range. MX15-1Pi: (10 kW), MX30-3Pi: (6.5 kW per output, 3 outputs. 20 kW in 1 channel mode), MX45-3Pi: (10 kW per output, 3 outputs. 30 kW in 1 channel mode)												
Voltage Ranges	Range: Low (0 - 200 V), High (0 - 400 V)												
Output Accuracy	± 1 Vdc												
Load Regulation	< 0.25 % FS												
Line Regulation	< 0.1% FS or 10 % line change												
Ripple	< 2 Vrms Lo Range, < 3 Vrms Hi Range												
Max DC Current @ FSV per output	Model	MX15-1Pi	MX30-3Pi / 1Phs	MX45-3Pi / 1Phs	MX90-3/Pi	MX135-3/Pi							
	V Low	50	33.3 / 100	50 / 150	100	150							
	V High	25	16.6 / 50	25 / 75	50	75							
Note: Constant power mode provides increased current at reduced voltage. See chart on previous page													
Current Limit	Programmable from 0 A to max. current for selected range												
AC+DC Mode Output													
Output (Pi) Power	Maximum current and power in AC+DC mode is same as DC mode												
Protection													
Over Load	Constant Current or Constant Voltage mode												
Over Temperature	Automatic shutdown												
Storage													
Non Volatile Mem. storage	16 instrument setups, 200 user defined waveforms [Pi only]												
Waveforms													
Waveform Types	Std: Sine, Pi: Sine, Square, Clipped sine, User defined												
User defined waveform storage	Four groups of 50 user defined arbitrary waveforms of 1024 points for a total of 200. One group can be active at a time												
System Interface													
Inputs	Remote shutdown, External Sync, Clock/Lock												
Outputs	Function Strobe / Trigger out, Clock/Lock												
Remote Control (Pi standard with -P option)													
IEEE-488 Interface	IEEE-488 (GPIB) talker listener. Subset: AH1, C0, DC1, DT1, L3, PPO, RL2, SH1, SR1, T6, IEEE-488.2 SCPI Syntax												
RS232C Interface	9 pin D-shell connector (Supplied with RS232C cable)												
LAN (option)	Ethernet Interface: 10BaseT, 100BaseT, RJ45												
USB	Version: USB 1.1; Speed: 460 Kb/s maximum												
Output Relay	Push button controlled or bus controlled output relay												
Output impedance (not available with -SNK Option)	Programmable Z available on MX30-3Pi and MX45-3Pi in 3 phase mode only. Specifications apply at 50 Hz fundamental. Resistive: 1 - 200 mOhm, Inductive: 15 - 200 uH												

MX Series II : Specifications

15–135 kVA

AC Input											
Voltage	Must be specified at time of order. All inputs are L-L, 3 ϕ , 3 wire + Gnd. 208 \pm 10% VAC, 230 \pm 10% VAC, 400 \pm 10% VAC, 480 \pm 10% VAC										
Input Line Current (per phase)	Current (MX15):										
	<table border="1"> <thead> <tr> <th>V L-L</th> <th>208</th> <th>230</th> <th>400</th> <th>480</th> </tr> </thead> <tbody> <tr> <td>St State</td> <td>58.3 ARMS</td> <td>52.3 ARMS</td> <td>30 ARMS</td> <td>25 ARMS</td> </tr> </tbody> </table>	V L-L	208	230	400	480	St State	58.3 ARMS	52.3 ARMS	30 ARMS	25 ARMS
	V L-L	208	230	400	480						
St State	58.3 ARMS	52.3 ARMS	30 ARMS	25 ARMS							
Current (MX30/45):											
	<table border="1"> <thead> <tr> <th>V L-L</th> <th>208</th> <th>230</th> <th>400</th> <th>480</th> </tr> </thead> <tbody> <tr> <td>St State</td> <td>116/175 ARMS</td> <td>105/157 ARMS</td> <td>60/90 ARMS</td> <td>50/75 ARMS</td> </tr> </tbody> </table>	V L-L	208	230	400	480	St State	116/175 ARMS	105/157 ARMS	60/90 ARMS	50/75 ARMS
V L-L	208	230	400	480							
St State	116/175 ARMS	105/157 ARMS	60/90 ARMS	50/75 ARMS							
Distortion: < 8 % at full power < 20 % below 35 % of power											
Line Frequency	47 - 63 Hz										
Efficiency	85 % typical										
Power Factor	0.95 typical										

AC Service	
Inputs/Outputs	MX30/MX45: Front access, cables routed through rear panel, exit in back. MX15: Rear Access
Regulatory	IEC61010, EN50081-2, EN50082-2, CE EMC and Safety Mark requirements
EMI	CISPR 11, Group1 , Class A
Connectors	AC Input & Output terminal block behind front cover, IEEE-488 (GPIB) connector (rear panel), 9 pin D-Shell RS232C connector*, (rear panel), Remote voltage sense terminal block (rear panel), System Interface Connector, DB-37 (rear panel). *RS232 DB9 to DB9 cable supplied

Physical Dimensions	
MX30/MX45 Dimensions	Height: 50.0" (1270 mm), Width: 28.75" (731 mm), Depth: 34.5" (876 mm)
MX30/MX45 Weight	Chassis: Net: 1150 lbs / 522 Kg, Shipping: 1231 lbs / 560 Kg, Amp Module: Net: 63 lbs / 29 Kg
MX15 Dimensions	Height: 31.75" (806 mm), Width: 24.0" (610 mm), Depth: 28.0" (711 mm)
MX15 Weight	Chassis: Net: 600 lbs / 272 Kg, Shipping: 681 lbs / 309 Kg, Amp Module: Net: 63 lbs / 29 Kg
Chassis	MX30/MX45: Casters and forklift openings. MX15: Casters
Vibration and Shock	Designed to meet NSTA project 1A transportation levels. Units are shipped in wooden crate with forklift slots
Air Intake/Exhaust	Forced air cooling, front air intake, rear exhaust
Operating Humidity	0 to 95 % RAH, non condensing
Temperature	Operating: 0 to 40° C (30° C max in CP mode), Storage: -20 to +85° C

Programmable controller versions with dual voltage ranges				
Model	AC Output Power	Phase Outputs	AC/DC Voltage Range	Controller
MX15-1Pi	15kVA	1	150/200 & 300/400	Programmable
MX30-3Pi	30 kVA	1 & 3	150/200 & 300/400	Programmable
MX45-3Pi	45 kVA	1 & 3	150/200 & 300/400	Programmable
MX90-3Pi	90 kVA	3	150/200 & 300/400	Programmable
MX135-3Pi	135 kVA	3	150/200 & 300/400	Programmable

Pi models include IEEE-488, RS232C & USB interfaces, Advanced measurements, arbitrary waveform generation. Phase mode switching on MX-30/45-3Pi.

-MB Option				
Model	AC Output Power	Phase Outputs	AC/DC Voltage Range	Controller
MX90-3Pi-MB	90 kVA	3	150/200 & 300/400	Dual MX45-3Pi
MX135-3Pi-MB	135 kVA	3	150/200 & 300/400	Triple MX-45-3Pi

Reconfigurable systems can be separated into stand-alone MX45-3Pi models or combined for higher power levels.

Steady State AC RMS Current in Regeneration Mode (-SNK Option)						
Model	MX15-1Pi	MX30-3Pi	MX45-3Pi	MX60-3Pi	MX90-3Pi	MX135-3Pi
V Low	100A	66.6/Ø / 200	100A/Ø/300	133.3/Ø	200/Ø	300/Ø
V High	50A	33.3/Ø / 100	50A/Ø/150	66.6/Ø	100/Ø	150/Ø

MX Series

Model

Refer to table shown for model numbers and configurations.

Supplied with

Standard: User Manual on CD ROM.
Pi version: User/Programming Manual and Software on CD ROM. RS232C serial cable.

Input Voltage Settings

Specify input voltage (L-L) setting for each MX system at time of order:

- 208 Configured for 208 V \pm 10 % L-L, 4 wire input.
- 230 Configured for 230 V \pm 10 % L-L, 4 wire input.
- 400 Configured for 400 V \pm 10 % L-L, 4 wire input.
- 480 Configured for 480 V \pm 10 % L-L, 4 wire input

Standard Model Options

Specify output range on standard models. All range values shown are Line to Neutral.

- 150 Configured for 150 V AC and 200 V DC output ranges.
- 300 Configured for 300 V AC and 400 V DC output ranges.

Pi Model Options

- 160 RTCA/DO-160D, DO-160E, and EUROCAE test firmware.
- 411 *IEC 1000-4-11 test firmware.
- LF Limits maximum frequency to 500 Hz.
- P IEEE-488 & RS232C Interface Adds programming, Windows & RS232 Cable.
- LAN Ethernet Interface.
- HF Increases max frequency to 1000 Hz.
- R Range change. Provides 150/200 & 300/400 AC/DC output ranges. (Std. MX15)

- 413 *IEC 1000-4-13 Harmonics & Interharmonics test firmware.
- 704 Mil Std 704 A - F test - firmware/ software.
- ABD ABD0100.1.8 Test Option.
- AMD Airbus AMD24 Test
- A350 Airbus Test Software
- B787 Boeing 787 Test Software
- HV Adds 400 V L-N AC-only output range.
- LF Limits max. frequency to 500 Hz.
- HF Increases max. frequency to 1000 Hz.
- XV Adds other AC-only output range. Consult factory.
- LKM Clock/Lock Master
- LKS Clock/Lock Auxiliary
- WHM Watt-Hour Measurement option.
- SNK Bidirectional auto source and sink mode. Offers up to 100% power sink capability.

Packaging and Shipment

All MX systems are packaged in re-usable protective wooden crates for shipment.

Feature Comparison

Model	Pi
AC mode	X
DC mode	X
AC+DC mode	X
Dual V Range	X
Transient programming	X
Arbitrary waveforms	X
Measurements	X
Harmonic measurements	X
Waveform acquisition	X
1 or 3 Phase mode	MX30/45-3Pi
IEEE / RS232	X

MX15 Dimensions - single chassis

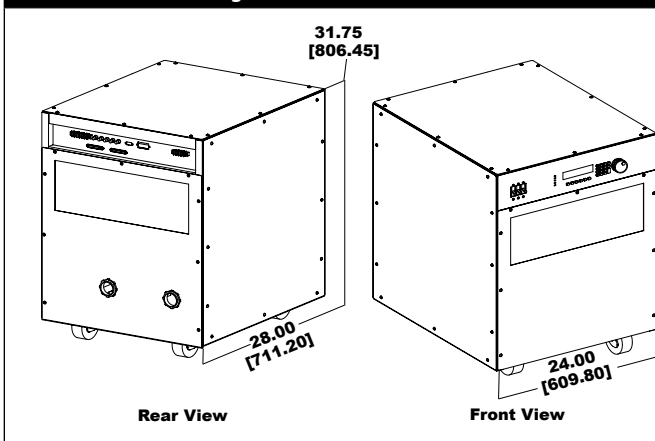

MX30/MX45 Dimensions - single chassis

